

Direct electrorefining of copper scrap using a titanium anode-support system in a monopolar cell

M. FIGUEROA*, R. GANA, L. KATTAN, A. PARODI

Departamento Química Analítica y Electroquímica, Facultad de Química, Pontificia Universidad Católica de Chile, Casilla 306, Correo 22, Santiago, Chile

Received 14 December 1992; revised 17 March 1993

This paper describes the application of an anode-support system to the direct electrorefining of copper scrap (> 95%) in sulphuric acid medium. The authors have established that it is possible to utilize a basket of titanium mesh as the anode-support, with chopped scrap inside the basket. It is feasible to utilize this system under the same operational conditions used for the industrial electrorefining of copper with conventional cast anodes. The proposed system avoids all the pyrometallurgical stages needed to produce the traditional cast anodes used in copper electrorefining and acts only as electrical contact between the anodic copper mass and the external current. Cathodes of good quality (> 99.98% Cu) were obtained after 14-day electrolyses, with a current yield of 98.5–99.0% and inventory savings of 48–57% referred to the conventional process using casting anodes.

1. Introduction

As is well-known, copper scrap refining requires pyrometallurgical and electrolytic processes. The scrap is initially subjected to smelting and pyrometallurgical refining to produce cast copper anodes. These anodes are electrorefined by the conventional process obtaining as final product high purity cathodes. In these stages the pyrometallurgical processes have a major impact on the cost of the final product because they consume nearly 50% of the energy involved in the overall process [1].

In this study the direct electrorefining of copper scrap (> 95% Cu) using the Walker system is proposed as an alternative to the conventional refining of the scrap metal. The process consists of replacing the cast anodes (CA) by a metallic 'anode-support' (AS) in the form of a basket with flat parallel perforated sides, in which the previously chopped scrap copper is placed. The AS acts only as an electrical contact between the external current source and the chopped copper material to be refined.

The $\text{CuSO}_4\text{-H}_2\text{SO}_4$ solution and the electrorefining operational parameters are the same as those used in the conventional process.

The basket must be made of a material with three basic characteristics: it must be a good electrical conductor, it must have an adequate mechanical resistance, and particularly it must remain passive in the electrolyte under the operational conditions used for the electrolysis.

There are important differences between the electrorefining process with CA and AS electrodes. In the AS system the metal to be refined is in the form of small pieces, so that it behaves as a 'fluid'

when compared to a CA electrode. The dissolution of the chopped metal anode in the system allows it to be accommodated continually within the basket, permitting periodical reloading without stopping the electrolysis. No anode scrap is produced as in the traditional process, where it is necessary to recycle 15% to 25% of the initial CA mass. The pyrometallurgical infrastructure required to cast the CA is replaced by a simple chopping of the metal scrap. The 'inventory' of metal being processed is reduced significantly.

The authors have applied this method industrially to the electrorefining of copper scrap and blister copper granules (Refinería La Florida, Santiago, Chile), using stainless steel AISI-316 as the material for the AS basket [2–5]. Additionally, the same system was employed on a laboratory scale for electrorefining 97% tin granules in sulphuric acid medium [6].

In this paper the use of titanium as an alternative metal for the AS basket is reported. The theoretical feasibility of utilizing a titanium AS in this process is based on the fact that this metal remains passive between -225 and $+600$ mV vs SCE in sulphuric acid 180 g dm^{-3} , 60°C . The copper dissolution potential is $+75$ mV vs SCE under the same operational conditions [7, 8].

2. Experimental details

Electrolyses were carried out in two types of acrylic cells, of 3 and 25 dm^3 capacity, with double walls for thermostatic control. The smaller cell had one AS central anode and two laminar copper cathodes. For comparison, the AS anode was replaced by a 3 mm thick laminar fire-refined copper (LA) of $120\text{ mm} \times 100\text{ mm}$. The 25 dm^3 cell had four anodes

* Author to whom all correspondence should be addressed.

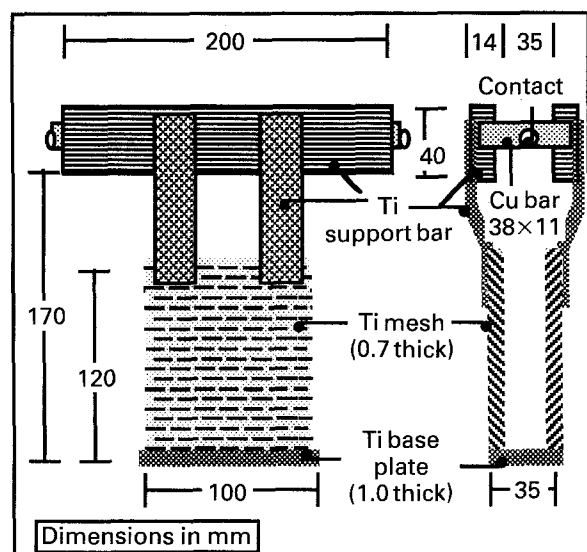

Fig. 1. Components and details of titanium anode-support system.

(two AS and two LA) and five copper cathodes, electrically connected according to the Walker system. All the 125 mm × 105 mm cathodes (starting sheets) were made of 0.3 mm thick fire-refined copper.

The 120 mm × 100 mm AS (baskets) had a 35 mm wide mouth with the walls made of 0.7 mm thick titanium mesh (Imperial Metal Ind. UK) having elongated horizontal perforations to prevent the chopped copper from falling to the bottom of the cell as the particle size decreased (Fig. 1). The cell bottom was made of an unperforated 1 mm thick titanium plate. It was possible to put in the AS system an acrylic piston to exert a mechanical pressure on the copper scrap pieces.

The scrap mass was obtained by chopping copper wire (1.0–4.0 mm diameter) in 8–14 mm long pieces. The chopped scrap was previously pickled in concentrated sulphuric acid and then washed with tap water, then distilled water and finally 95% ethanol. It was dried with hot air.

The electrolyte solution was recirculated with a peristaltic pump by the bottom–top system and heated externally in a Pyrex beaker by means of a quartz heater with thermoregulator (0.5 kW for the small cell and 2 kW for the large one). The flow rate was controlled with a rotameter. A Hewlett-Packard Leader 682 stabilized power supply was used (1–24 V, 2.4 A), and the electric charge was measured

Table 1. Standard electrolyte solution and operational parameters.

Standard electrolyte solution*	
CuSO ₄ ·5H ₂ O	180 g dm ⁻³
H ₂ SO ₄	180 g dm ⁻³
Standard operational parameters	
Projected anode–cathode area	1.2 dm ²
Apparent current density†(<i>j</i>)	2.0 A dm ⁻²
Electrode spacing (face to face)	3.0 cm
Temperature	60 ± 1°C
Electrolyte flow (small and large cell)	0.35–0.75 dm ³ min ⁻¹

* No additives were used.

† The frontal mesh side of the basket is considered in the case of the anode.

with an LYP – Electronic Digital coulometer, model Cd-02.

The standard electrolyte composition and the operational parameters are indicated in Table 1.

Measurements of the working potential of copper and titanium in the AS system were made using a Luggin probe (vs SCE) after 1 h electrolysis at five points on the mesh walls and four points on the copper scrap, placing the probe through the holes in the rolled metal.

Measurements of the final copper thickness of diverse cathode areas were made using a magnetic gauge Diameter SM-1y.

3. Results and discussion

Figure 2 shows the working anodic potential variation when the apparent current density (j_a) was increased from 0.4 to 3.0 A dm⁻², using the standard operational parameters. The values obtained are the average of those measured at the different points on the titanium mesh and the copper mass, the standard deviation being no more than 0.2 mV. It is important to confirm that the working potential for titanium in the j_a range studied is outside the active corrosion zone.

It can be observed that the potential varies practically linearly with current density and that the AS electrode is not an equipotential system, the titanium mesh having a more positive potential than the particulate copper. In the system the titanium surface is passivated because of the formation of a thin oxide layer. Several authors have postulated the formation of oxide in diverse oxidation states (Ti_xO_y), other than TiO₂. The latter oxide is obtained only under very strong oxidizing conditions [9–12].

In a titanium–copper system with two laminar electrodes, under zero current and standard conditions, the existence of an electrochemical cell consisting of (+)Ti/Ti_xO_y/standard electrolyte

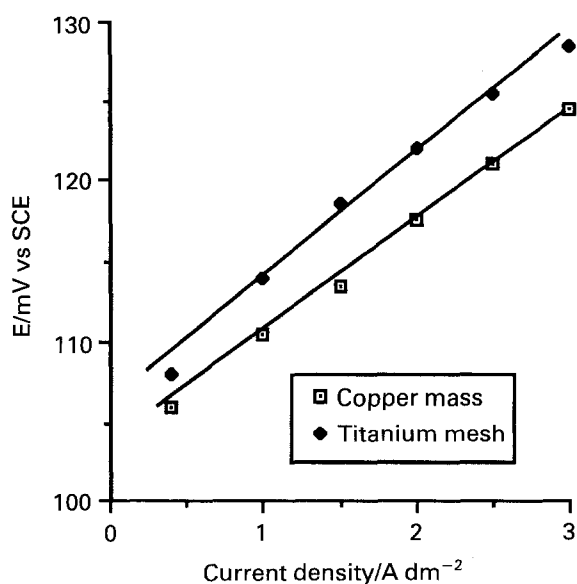

Fig. 2. Effect of the apparent current density on copper mass and titanium mesh potential in the AS system.

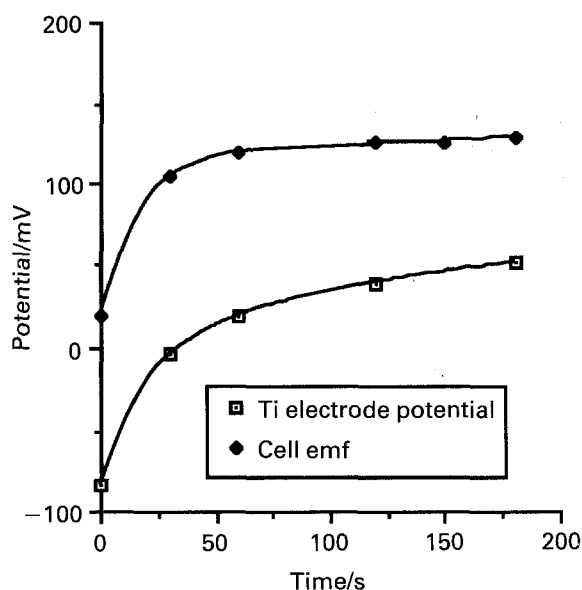
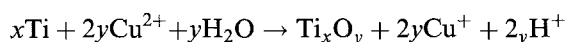

Fig. 3. E.m.f. variation against time of the cell $\text{Ti}/\text{Ti}_x\text{O}_y$, standard solution/Cu.

solution/Cu(-) was detected. In order to quantify the e.m.f. of this cell, a titanium plate was pickled with a 20% HCl-4% NaF solution for 1 min, then washed for 5 s with distilled water and immediately placed in the electrolyte solution, which had been already degassed by bubbling nitrogen for 20 min. The cell e.m.f. and the titanium potential (vs SCE) were measured continuously for 3 min.

Figure 3 indicates the variation of the cell e.m.f. and the titanium potential with time. Initially, the pickled titanium acts as anode in the cell, but the oxidation of the metal surface is very rapid in the solution and after approximately 30 s the e.m.f. becomes zero and there is a change in the cell polarity. The titanium potential acquires a more positive value as the oxide layer thickness increases. It has been reported that when the thickness rises from 10 to 30 nm, the potential varies from +160 to +225 mV [10]. The presence of Cu^{2+} in the solution helps the oxidation of the titanium surface, according to the reaction [13]:



After 30 min the cell e.m.f. is 93 mV, increasing to 250 mV after 24 h. This last value remains constant between 24 and 240 h.

Additionally, Fig. 3 shows that the $\text{Ti}/\text{Ti}_x\text{O}_y$ potential (vs SCE) is initially +20 mV, and becomes +130 mV after 3 min of cell functioning. This value increases to +350 mV after 24 h and remains constant until 240 h. The positive initial value indicates that the titanium oxide layer commences its formation on the laminar surface during the washing operation. In fact, when this operation was made for 15 s, the initial potential was approximately $+100 \pm 10$ mV and it was not possible to detect a change in the cell polarity.

In two 3 dm^3 cells the voltage variation was studied as function of the current density, using two laminar copper cathodes and a central anode. As anode (i) an AS electrode and (ii) a copper LA electrode were used with the same projected area as in the AS

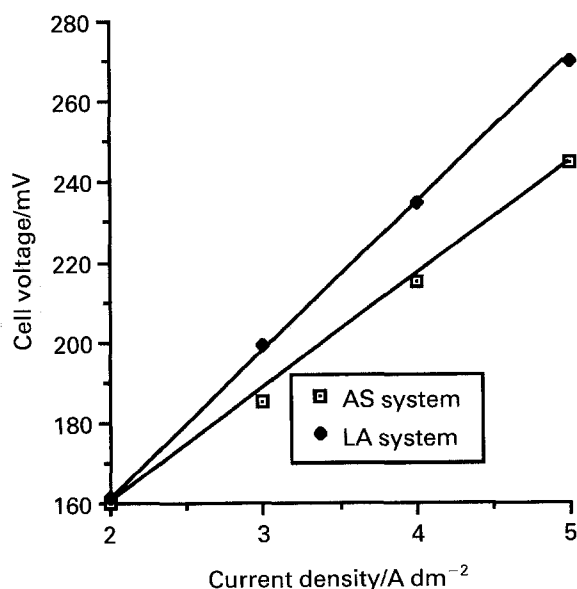

Fig. 4. Effect of current density on cell voltage, after 30 min electrolyses under standard operational conditions, using as anodes AS and LA systems with the same projected area.

system. The electrolyses were carried out for 30 min using standard conditions. Figure 4 indicates that in both cases the voltage variation is practically linear with the current density between 2.0 and 5.0 A dm^{-2} . The cell voltage for the system with the AS electrode is less than that using an LA electrode over the range studied. Two main factors can explain this behaviour. The first one is the large real surface that the particulate copper anode (AS) presents so that the actual anodic current density is smaller than its calculated value considering the geometric basket area. A second less important factor is the decrease in the thickness of the anodic diffusion layer in the AS system, as a consequence of the convection phenomenon caused by the circulation of the electrolyte through the chopped copper anode.

Figure 5 shows the variation in the cell voltage as the quantity of chopped copper scrap decreases in

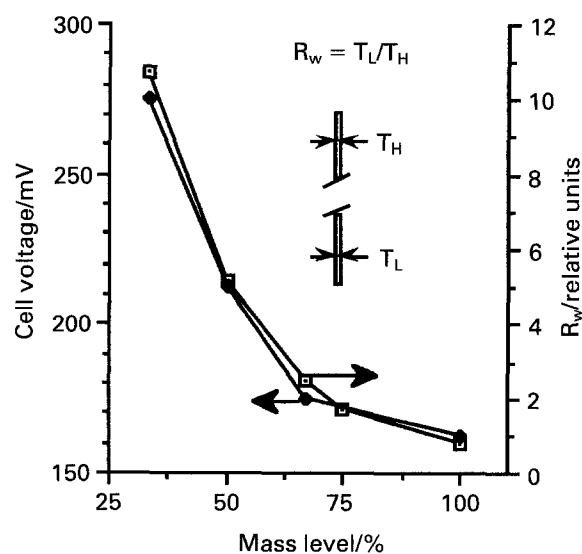

Fig. 5. Cell voltage and R_w variation as a function of the level of chopped copper scrap in the titanium AS system, using standard operational conditions.

the AS system, after a 2 h electrolysis was run in the 3 dm³ cell using standard conditions. If the amount of scrap in the basket is adjusted so as not to fall below 3/4 of the full load, the voltage can be maintained within a 7% fluctuation, but if the level drops to 1/2, the voltage increase reaches 34%.

The level of the particulate copper in the basket is very important, because for geometric reasons, a 'wedge effect' is produced by the copper deposited on a central cathode placed between two AS electrodes. The authors have established the relation $R_w = T_L/T_H$ to quantify this wedge effect, T_L being the lower and T_H the higher boundary thickness measured 10 mm from the lower and from the upper end of the cathode (see Fig. 5). The R_w values in the cathodes fluctuated between 1.05 (full mass level) and 10.1 (1/3 mass level) when 10.8 A h were employed. When the two AS fully-loaded electrodes were replaced by two LA fire-refined copper electrodes with the same working area, an R_w of 1.09 was obtained.

Using standard conditions, 48 h electrolyses were carried out reloading the baskets when the level of the particulate copper dropped to 2/3 of the total mass. A very favourable R_w value of 1.10 was obtained. A second experiment was carried out using the same parameters, but without reloading the copper mass into the baskets. The final copper level was approximately 1/2 of the initial mass, the R_w value was 1.60, and the resulting cathode had clearly a wedge form with the thick area in the lower level. In both cases the R_w values are better than those indicated in Fig. 5 for the 2/3 and 1/2 levels, because the 48 h electrolyses started with a full level mass of compressed chopped copper which does not change significantly during the first 20–24 h of electrolysis. For these reasons, in long-time electrolyses, it is advised

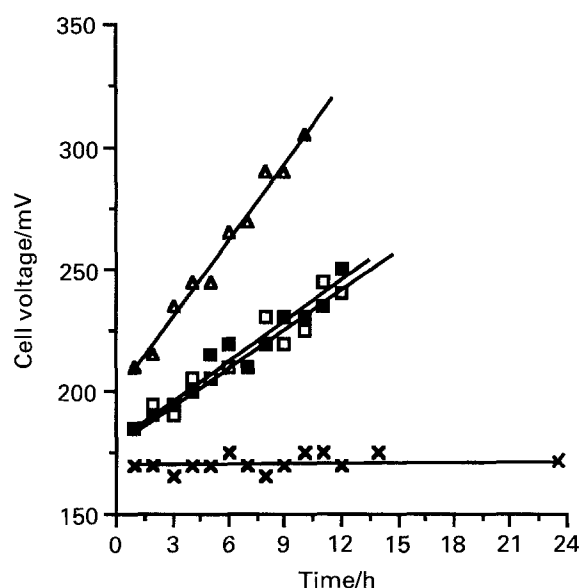

Fig. 6. Cell voltage against time for various types of electrical contact between the copper mass and the titanium AS system, using standard operational conditions. Key: (Δ) basket with conducting walls; (■) basket with conducting bottom; (□) basket with conducting walls and bottom; and (X) basket with conducting bottom, exerting mechanical pressure: 0.05 kg cm⁻².

to reload the basket with chopped copper when the level drops to 2/3 of the initial mass.

In the 3 dm³ cell, it was established that a variation of the electrolyte flow between 0.35 and 0.70 dm³ min⁻¹ did not have a detectable influence on the R_w values.

To determine the more effective AS areas with respect to the electrical contact between the copper mass and the titanium basket, three 12 h electrolyses were carried out using the standard operational conditions, maintaining in all cases fully loaded AS electrodes. In the first electrolysis the titanium bottom plate of the basket was isolated by covering it with a nonconducting nitrocellulose varnish. In the second electrolysis only the internal face of the titanium mesh walls was isolated and the third electrolysis was run without using the varnish. Figure 6 shows the cell voltage variation under the above-mentioned conditions. It can be seen that the contribution of the walls to the electrical contact is not important, because the lowest cell voltage is obtained when the titanium bottom plate is varnish free, independent of the contribution from the mesh sides.

Using the same AS system with all the mesh walls covered with varnish, except the bottom one, a 24 h electrolysis was run maintaining the full copper scrap level and exerting a mechanical pressure with an acrylic piston on the particulate anode mass. In Fig. 6 it can be noted that when 0.05 kg cm⁻² pressure was exerted on the copper mass, no variation of the cell voltage was detected during the electrolysis. In fact, the pressure exerted by the copper pieces on the bottom of the titanium basket must contribute to maintaining a good electrical contact in the AS system, because the titanium oxide thin layer is broken.

In order to compare the AS with the LA system, a 100 h electrolysis was carried out in the 25 dm³ cell using the standard operational conditions. Figure 7 shows the electrochemical system with five cathodes, two AS and two LA anodes. The bottom-top solution flow, at a rate of 0.75 dm³ min⁻¹, permitted a temperature gradient of no more than 1.5° C between the electrolyte inlet and outlet. The amount of chopped copper scrap in the AS electrodes was adjusted so as not to fall below 2/3 of the full load. A 0.05 kg cm⁻² pressure was exerted continuously on the copper mass.

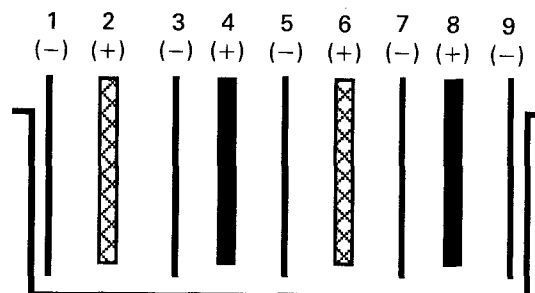

Fig. 7. Schematic of 25 dm³ cell. Electrodes: (1–3–5–7–9) copper laminar cathodes; (2–6) AS electrodes; (4–8) LA fire-refined copper electrodes; and electrode spacing: 3.0 cm face to face.

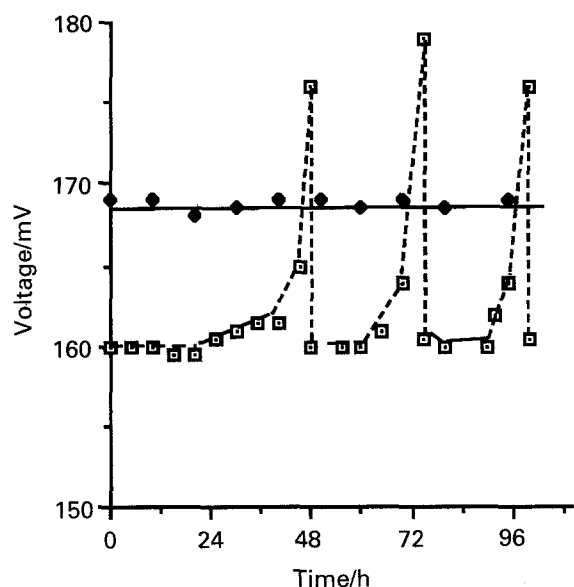

Fig. 8. Average pair voltage variation with electrolysis time, using standard operational conditions in a 25 dm^3 cell. A 0.05 kg cm^{-2} mechanical pressure was exerted continuously on the copper mass in the AS system. Key: (\square) couples AS-cathodes; (\blacklozenge) couples LA-cathodes.

An acceptable copper crystallization was obtained for all five cathodes, independent of their cell position.

Figure 8 shows the average pair voltage variation with electrolysis time for the four couples AS system-adjacent cathodes (1-2, 2-3, 5-6, 6-7) and for the couples LA electrodes-adjacent cathodes (3-4, 4-5, 7-8, 8-9). It can be seen that the pair voltage for the couples with the LA electrodes remained practically steady at 168-170 mV. On the other hand, the average pair voltage for the AS systems was initially lower than that corresponding to the LA systems. However, when the amount of copper in the basket became 2/3 of the initial level, the voltage pair rose above 175 mV. When the AS system was reloaded to the original level, the voltage pair returned to its

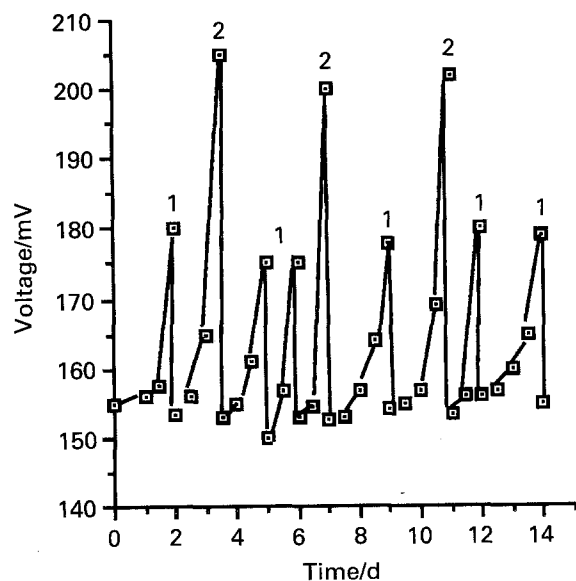

Fig. 9. Average pair voltage variation with electrolysis time, using standard operational conditions in a 25 dm^3 cell with the AS system, exerting a 0.05 kg cm^{-2} mechanical pressure on the copper mass. (1) reloading with level 2/3; (2) reloading with level 1/2.

initial value (158-160 mV). In the first step of the electrolysis it was necessary to reload the basket after 48 h because the initial loading was a very compressed mass of copper scrap. From then this operation was done every 25-27 h.

Using the above operational conditions in the 25 dm^3 cell, a 14-day electrolysis was carried out utilizing only AS electrodes and laminar copper cathodes. In order to compare the pair voltage variation, the reloading of copper in the baskets was carried out when the level dropped to 2/3 or 1/2 of the initial loading.

Figure 9 indicates the variation with electrolysis time of the average voltage pair between each AS and the adjacent cathodes. If all of the AS baskets were reloaded when the copper mass became 2/3 of the initial level, it was possible to maintain the average voltage pair between 158 and 180 mV. However, if the level dropped to 1/2 of its original loading, the voltage values rose above 200 mV.

It is interesting to note that during this long-time experiment, the reloading operation was repeated several times, and in all cases the voltage pair dropped immediately after this operation to the initial value (158-160 mV).

The final central cathodes obtained after 14 days of continuous electrolysis showed a noticeable increase in the wedge effect, with R_w values between 1.12 and 1.26.

It was observed that the variation of the Cu^{2+} and H_2SO_4 concentrations at the end of the electrolysis depended on the pretreatment of the chopped copper scrap. Usually, scrap copper wire consists of burned material (to eliminate the plastic covering), with a very oxidized surface. If the scrap was previously pickled in sulphuric acid, the wire surface remained clean and after the application of 100 Ah current the electrolyte concentration rose between 0.30 and 0.32 g dm^{-3} for the cupric ion and between 0.50 and 0.54 g dm^{-3} for sulphuric acid. On the other hand, if the copper was not pickled, the changes in concentration were greater, viz. $0.44\text{-}0.46 \text{ g dm}^{-3}$ for copper and $0.84\text{-}0.86 \text{ g dm}^{-3}$ for sulphuric acid. A trend towards decreasing sulphuric acid and increasing copper ion concentrations is due mainly to the reaction of the acid with the copper oxide layer and by the secondary reaction: $\text{Cu} + 2\text{H}^+ + \frac{1}{2}\text{O}_2 \rightarrow \text{Cu}^{2+} + \text{H}_2\text{O}$. Additionally, the Cu^{2+} concentration increases because in the electrorefining process the anodic current efficiency is always greater than the cathodic one.

The amount of anode slime coming from the AS system after 1350 Ah was $8.5 \text{ g (kg refined copper)}^{-1}$. This figure falls in the industrial electrorefining range, viz. $1.6\text{-}15 \text{ g (kg refined copper)}^{-1}$ [14].

However, the anode slime recovered from the experimental cell was in the form of fine particles with a high copper content (> 95%). This value is in sharp contrast with the 12-73% copper found in the anode slime in industrial refineries [14]. This difference in copper content is logical, because the

composition of the slime depends on the anode purity. In the AS system the chopped wire analyzed is > 99.97% Cu. Anode slime was formed by two types of particles, mainly by small pieces of wire that fell to the bottom of the cell through the titanium mesh holes and by copper powder produced by chemical reactions, especially if burnt covered copper wire was used:

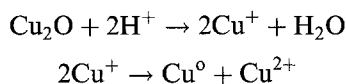

As expected, the quality of the copper cathodes corresponded to electrolytic copper (> 99.98% Cu) with a current efficiency of 98.5–99.0%.

At this experimental level, the AS system involves a reduction in copper inventory in the order of 48–57% compared to the conventional process, since the chopped copper mass occupies a volume approximately 4.2–4.5 times larger than an equal mass of cast metal. To detect any possible attack on the titanium, three sheets of titanium were connected electrically both inside and outside the AS basket. After a total of more than 10 000 Ah, in several electrolyses under the standard operational conditions, no pitting of the samples could be seen and a weight loss in the range 0–0.38 mg Ti/kg refined copper was observed, without any relation to the location of the samples or to the pretreatment of the copper, prior to electrolysis.

4. Conclusions

This study has shown that it is feasible to utilize a titanium anode-support (AS) system for the direct electrorefining of chopped copper scrap (> 95% Cu) using operational parameters similar to those employed in the conventional electrorefining process.

Titanium remains passive under the standard operational conditions, and after 10 000 Ah of electrolysis no pitting of the metal could be observed, the weight loss of titanium being not significant.

Using the AS system it is possible to carry out long-duration copper electrorefining maintaining the average pair voltage under that corresponding to the same process with cast copper anodes. To achieve this goal it is important to reload the AS baskets periodically with chopped scrap to avoid the amount of copper mass dropping to less than 2/3 of the full level. As the full level of copper is restored, the pair voltage decreases to its low initial value.

In order to obtain an adequate electrical contact in the AS system, it is important to exert a mechanical pressure on the copper mass. In this way the titanium oxide thin layer can be more easily broken, particularly at the bottom of the basket.

For geometric reasons, if the copper loading in the basket drops, the current distribution on the cathodes is not uniform. The thickness of the copper deposited on the cathodes is thinner on the upper parts and a wedge effect is produced. If the amount of copper in the AS system is adjusted so as not to fall below 2/3 of the initial loading, a very favourable R_w value of 1.10 can be obtained.

It is advisable to pickle the copper scrap before loading it into the titanium basket to eliminate the copper oxide layer, particularly if burnt covered wire is utilized as raw material. In this way it is possible to limit the increase in cupric ion concentration and the decrease in the sulphuric acid concentration of the electrolyte during the electrorefining process.

An anode slime in the form of fine particles with a high copper content (> 95%) is obtained in the process. Its amount in g per kg refined copper is within the usual range found in industrial copper electrorefining.

The quality of the copper cathodes was good (> 99.98% Cu) with a current efficiency of 98.5–99.0%.

Acknowledgements

The authors are grateful for support from the Dirección de Investigación de la Pontificia Universidad Católica de Chile (DIUC) and from the Fondo Nacional de Desarrollo Científico y Tecnológico (FONDECYT).

References

- [1] R. Gana, M. Figueroa and A. Parodi, III Simposio Brasileiro de Electroquímica, Sao Paulo, Brasil (1982) 556.
- [2] R. Gana and M. Figueroa, *Chilean Patent 31 869* (1980).
- [3] R. Gana and M. Figueroa, *Chilean Patent 32 091* (1981).
- [4] R. Gana, M. Figueroa and A. Parodi, Proc. Mining Latin America I.M.M. Edit. (1986) 131.
- [5] R. Gana, M. Figueroa and R. González, in *Proceedings of Hydrometallurgy and Electrometallurgy of Copper, Copper 87*; (edited by W. C. Cooper, G. E. Lagos and G. Ugarte); vol. 3, Santiago, Chile (1988) 433.
- [6] R. Gana, M. Figueroa, L. Kattan and J. M. Orpinas, *J. Appl. Electrochem* **23** (1993) 60.
- [7] A. Parodi, Tesis de pregrado, Facultad de Química, P. Universidad Católica de Chile, Santiago, Chile (1978).
- [8] R. Gana and R. Larráin, III Reunión Latinoamericana de Electroquímica y Corrosión, La Plata, Argentina (1977) 398.
- [9] N. Tomashov and G. Chernova, 'Passivity and Protection of Metals Against Corrosion', Plenum Press, New York (1967) p. 9 and p. 35.
- [10] Y. A. Klinov, 'Corrosion and Protection of Materials'. Consultants Bureau, New York (1962) p. 80.
- [11] C. Bedford, W. Weeks and A. Caterson, *Chem. Eng.* **63**(12) (1956) 238.
- [12] H. Uhlig, 'Corrosion et Protection', Dunod, Paris, (1970) p. 327.
- [13] Imperial Metal Industries, 'Corrosion Resistance of Titanium', Birmingham, UK (1978).
- [14] C. L. Mantell, Industrial Electrochemistry, McGraw-Hill, New York (1950).